

---

# CAVA ALBORENSIS

SORGENTE DI MATERIA

---



  
KRONOS  
CERAMICHE

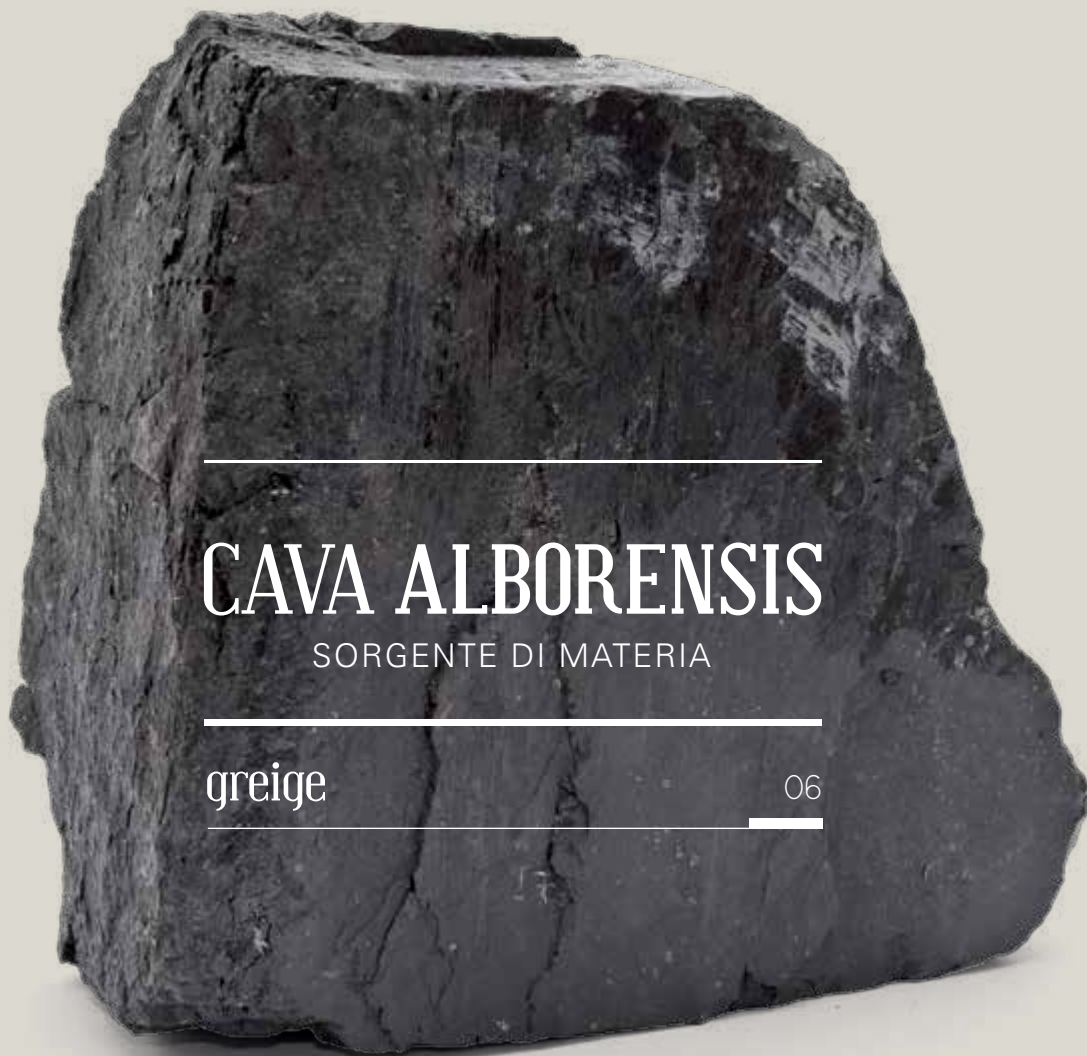

---

# CAVA ALBORENSIS

SORGENTE DI MATERIA

---

greige

06

---

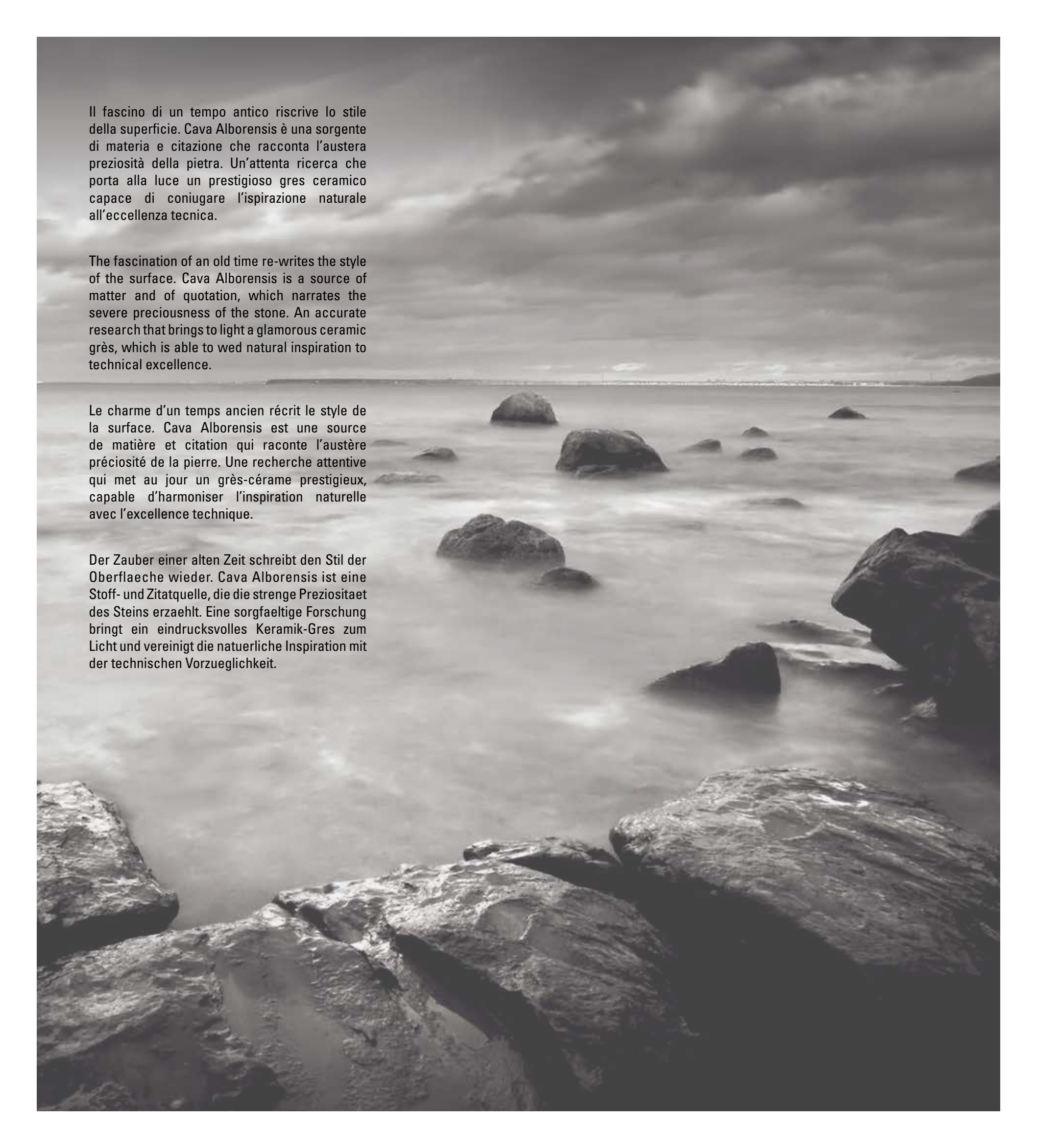

Il fascino di un tempo antico riscrive lo stile della superficie. Cava Alborensis è una sorgente di materia e citazione che racconta l'austera preziosità della pietra. Un'attenta ricerca che porta alla luce un prestigioso gres ceramico capace di coniugare l'ispirazione naturale all'eccellenza tecnica.

The fascination of an old time re-writes the style of the surface. Cava Alborensis is a source of matter and of quotation, which narrates the severe preciousness of the stone. An accurate research that brings to light a glamorous ceramic grès, which is able to wed natural inspiration to technical excellence.

Le charme d'un temps ancien récrit le style de la surface. Cava Alborensis est une source de matière et citation qui raconte l'austère préciosité de la pierre. Une recherche attentive qui met au jour un grès-cérame prestigieux, capable d'harmoniser l'inspiration naturelle avec l'excellence technique.

Der Zauber einer alten Zeit schreibt den Stil der Oberfläche wieder. Cava Alborensis ist eine Stoff- und Zitatquelle, die die strenge Preziosität des Steins erzählt. Eine sorgfältige Forschung bringt ein eindrucksvolles Keramik-Gres zum Licht und vereinigt die natürliche Inspiration mit der technischen Vorzüglichkeit.





lappato

naturale

bocciardato

Gres porcellanato colorato in massa  
Full body coloured porcelain  
Grès-cérame coloré pleine masse  
In der Masse gefärbtes Feinsteinzeug

**CAVA ALBORENSIS**

SORGENTE DI MATERIA



greige

60x60 - 30x60 - 30x30 naturale  
10x60 battiscopa



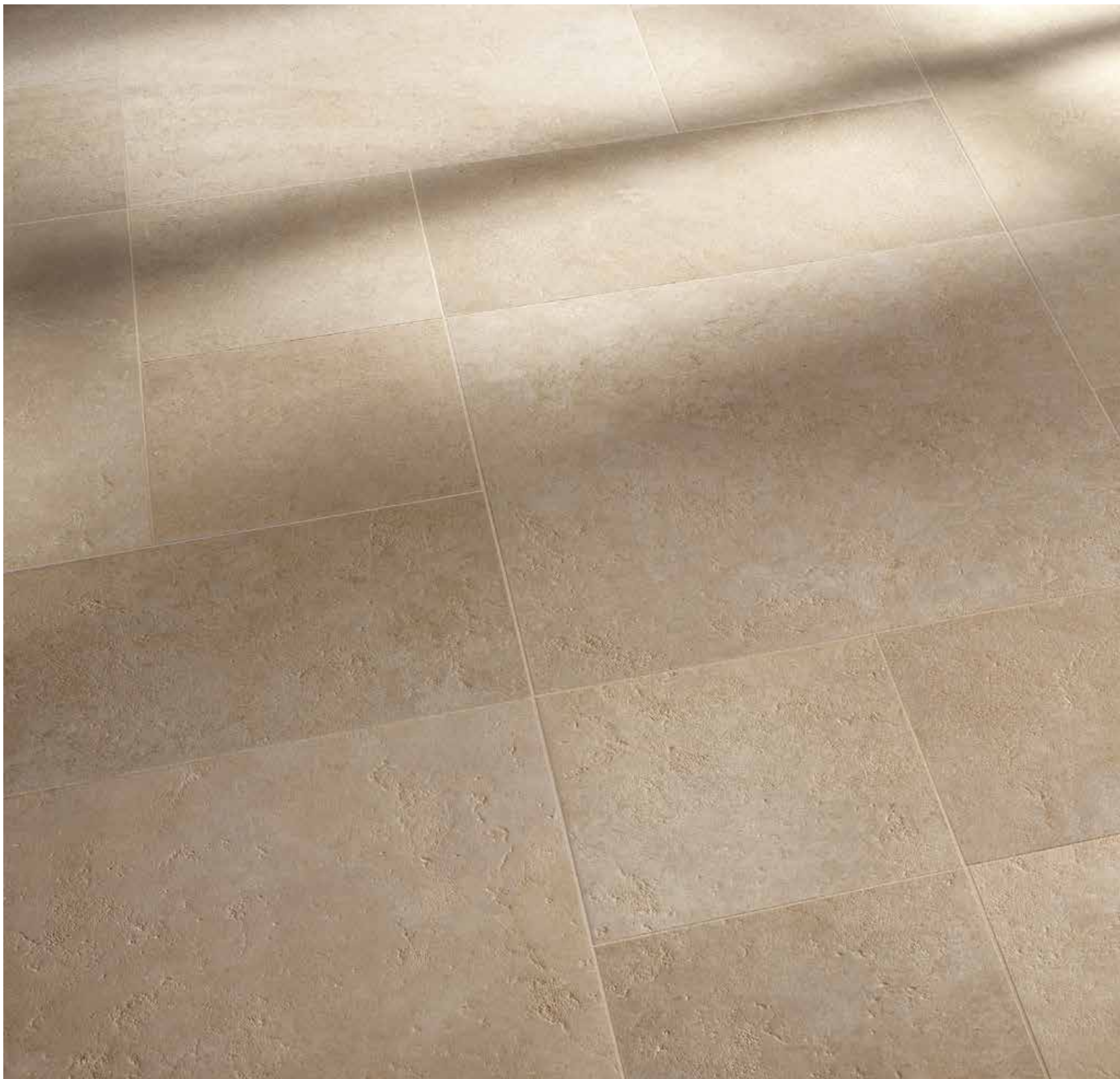

greige

60x60 - 30x60 - 30x30 naturale



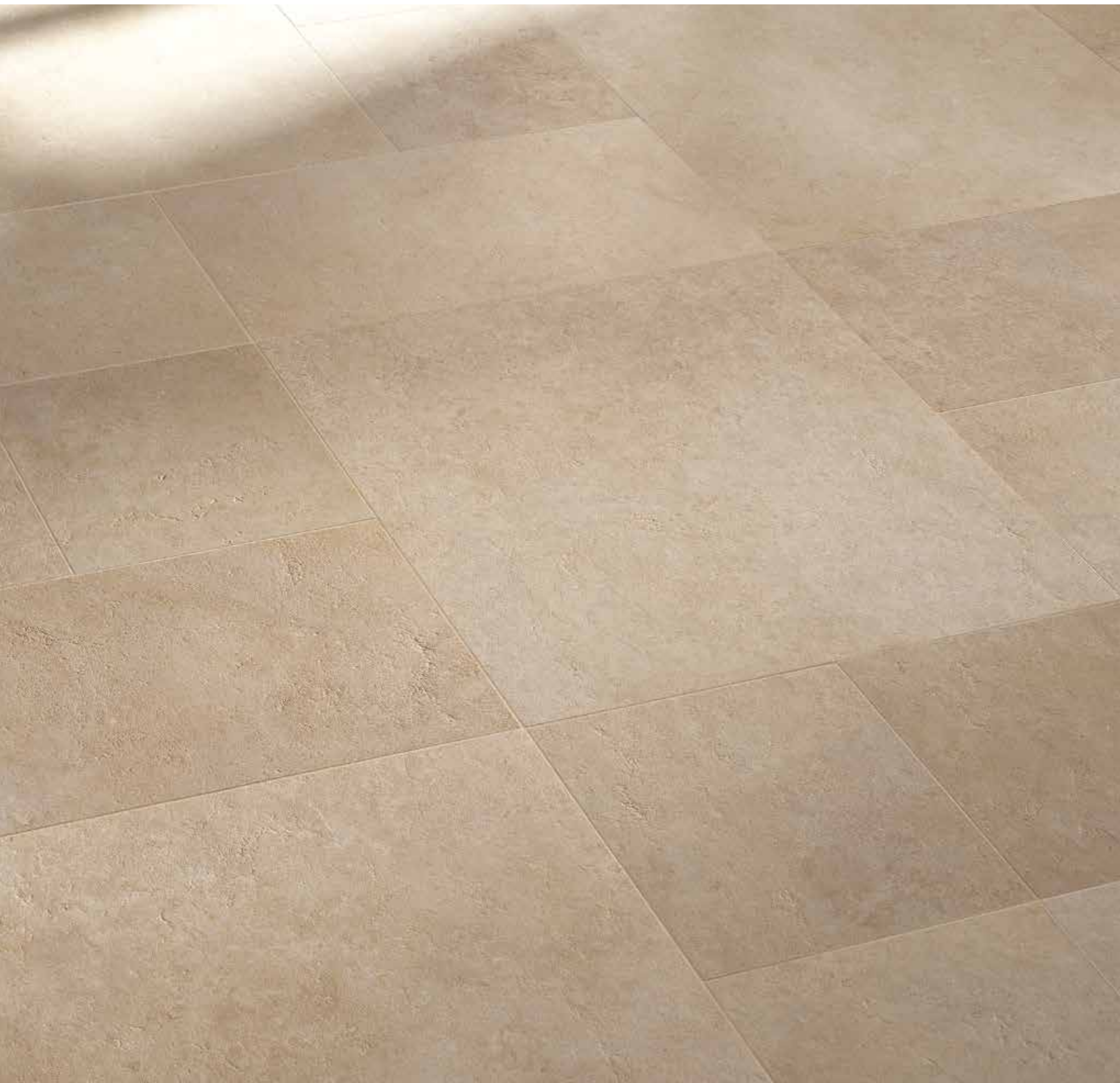



Pianta scalino

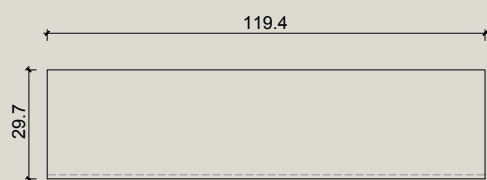

Vista frontale scalino

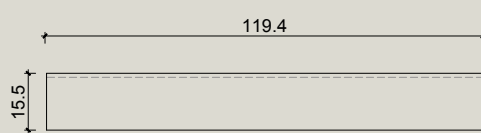

Sezione scalini

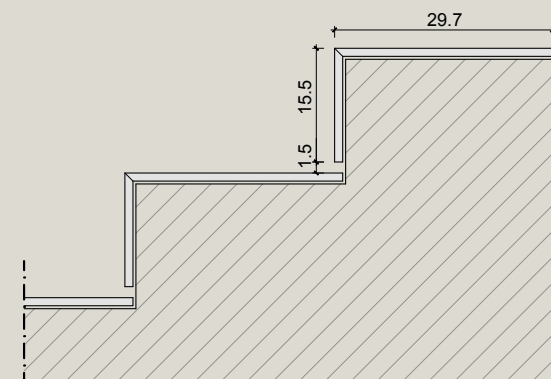

greige

Scalini con lavorazioni a "elle"



# greige



V3

naturale



**60x120** GREIGE  
5947 | Naturale rett.  
5948 | Lappato rett.  
5966 | Bocciardato rett.



**60x60** GREIGE  
5901 | Naturale rett.  
5902 | Lappato rett.  
5968 | Bocciardato rett.

**MODERATA VARIAZIONE**  
La casualità cromatica di questo prodotto permette di esprimere il carattere e il calore di ogni piastrella e la naturalezza del prodotto estratto dalla cava.

**LIGHT VARIATION**  
The chromatic casualness of this product expresses the nature and the warmth of each tile, as if it really came out naturally from the quarry.

lappato



**30x60** GREIGE  
5903 | Naturale rett.  
5904 | Lappato rett.  
\*5970 | Bocciardato  
\*Non rettificato / Non-rectified  
Non rectifié / Nicht rektifiziert

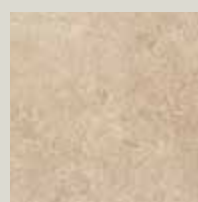

**30x30** GREIGE  
5969 | Naturale rett.  
5973 | Lappato rett.



**60x60**  
Dec. stella  
6033



**15x60**  
List. stella  
6035



**15x15**  
Ang. list. stella  
6037



**1,5x30**  
Square  
2290

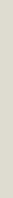

**1,5x31**  
Square corner  
2295

bocciardato



**30x30**  
Anticato mix  
tessere 3x3  
5980



**30x30**  
Mattone  
tessere 7,5x15  
5981



**30x30**  
Mosaico fiore mix  
5982



**9x30**  
Listello fiore  
5985



**1,5x60**  
Chiusura fiore  
6022

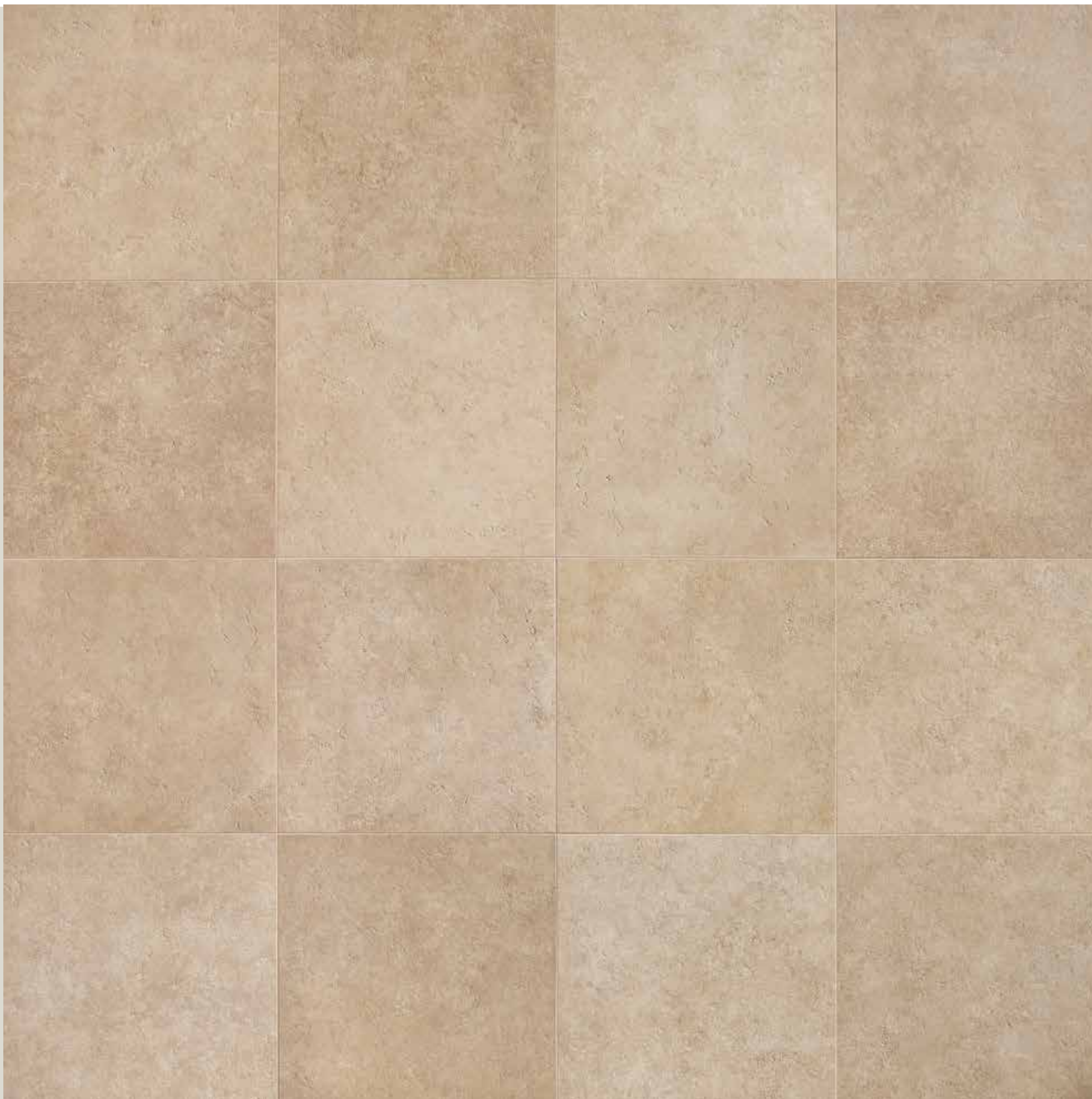

**10x60** battiscopa  
5989



**33x120** gradino  
5992



**60x33** gradino  
5995



**33x33** angolare  
5998



**10x60 h6 cm** elemento L  
bocciardato 6003



# greige vintage

Modulo vintage  
60x60 - 40x60 - 20x60 - 20x20 - 40x40 - 20x40

# vintage

Vintage è un metodo di lavorazione manuale che permette di ottenere tutti i lati diversi e crea l'emozione del prodotto anticato e "vissuto" tipico delle maisons di pregio.

Vintage is a method of manual workmanship which makes all sides of the tile different to each other, giving the emotion of an old-fashioned product, typical of valuable "maisons".

Vintage est une méthode de travail manuel qui permet d'obtenir tous les côtés différents et qui donne l'émotion du produit vieilli et « vécu », typique des maisons de valeur.

Vintage ist eine Methode von Handarbeit, die alle Seiten der Fliese anders macht, um die Emotion eines antiken und « gelebten » Produktes zu geben, das typisch von den wertvollen « Maisons » ist.



## greige

20x60 - 20x40 - 20x20 vintage

# greige vintage



V3

**MODERATA VARIAZIONE**  
La casualità cromatica di questo prodotto permette di esprimere il carattere e il calore di ogni piastrella e la naturalezza del prodotto estratto dalla cava.

**LIGHT VARIATION**  
The chromatic casualness of this product expresses the nature and the warmth of each tile, as if it really came out naturally from the quarry.



**60x60**  
9411 Naturale



**40x60**  
9415 Naturale



**40x40**  
9412 Naturale



**20x60**  
9416 Naturale



**20x40**  
9413 Naturale



**20x20**  
9414 Naturale



GRES PORCELLANATO COLORATO IN MASSA / FULL BODY COLOURED PORCELAIN  
GRES-CERAME COLORE PLEINE MASSE / IN DER MASSE GEFÄRBTES FEINSTEINZEUG







CARATTERISTICHE E PROPRIETÀ \_ CHARACTERISTICS OR PROPERTIES  
 CARACTÉRISTIQUES OU PROPRIÉTÉS\_ EIGENSCHAFTEN UND GÜTEMERKMALE

NORME STANDARDS NORMES NORMEN	Caratteristiche e proprietà Characteristics or properties Caractéristiques ou propriétés Eigenschaften und Gütemerkmale	Secondo le norme Compliance with standards Conforme aux normes Entsprechend den normen UNI EN 14411 G	
ISO 10545-3	Assorbimento d' acqua Water absorption Absorption d'eau Wasseraufnahme	E <= 0,04 %	Conforme alle norme Complies with standard Conforme aux normes Normgerecht
ISO 10545-9	Resistenza agli sbalzi termici Thermal shock resistance Résistance aux écarts thermiques Temperaturwechselbeständigkeit	Richiesta Requested Demandée Auf Anfrage	Conforme alle norme Complies with standard Conforme aux normes Normgerecht
ISO 10545-12	Resistenza al gelo Frost resistance Résistance au gel Frostbeständigkeit	Richiesta Requested Demandée Auf Anfrage	Conforme alle norme Complies with standard Conforme aux normes Normgerecht
ISO 10545-6	Resistenza all'abrasione Abrasive wear Résistance à l'abrasion Abriebfestigkeit	<128 mm <sup>3</sup>	Conforme alle norme Complies with standard Conforme aux normes Normgerecht
ISO 10545-2	Spessore Thickness Épaisseur Stärke	10 mm	Conforme alle norme Complies with standard Conforme aux normes Normgerecht
	Lunghezza e larghezza Length and width Longueur et largeur Länge und Breite	+/- 0,5 %	Conforme alle norme Complies with standard Conforme aux normes Normgerecht
ISO 10545-4	Resistenza alla flessione Bending strength Résistance à la flexion Biegezugfestigkeit	-	53 N/mm <sup>2</sup>
ISO 10545-14	Resistenza alle macchie Resistance to stain Résistance aux taches Fleckenfestigkeit	-	5
ISO 10545-13	Resistenza agli agenti chimici Chemical resistance Résistance à l'attaque chimique Beständigkeit gegen Chemikalien	-	UA ULA UHA
DIN 51130	Resistenza allo scivolamento Slip resistance Résistance au glissement Bestimmung der rutschhemmende eigenschaft	-	R10 naturale R11 bocciardato
DIN 51097	Resistenza allo scivolamento Slip resistance Résistance au glissement Bestimmung der rutschhemmende eigenschaft	-	A naturale B bocciardato
B.C.R.A. C.A. B.C.R.A. G.B. D.M. 236 del 4.6.1989	Resistenza allo scivolamento Slip resistance Résistance au glissement Bestimmung der rutschhemmende eigenschaft	Tortus Test	0,62 DRY / 0,53 WET naturale 0,65 DRY / 0,47 WET bocciardato
ASTM C 1028/07	Resistenza allo scivolamento Slip resistance Résistance au glissement Bestimmung der rutschhemmende eigenschaft	-	0,79 DRY / 0,62 WET naturale 0,76 DRY / 0,62 WET bocciardato

IMBALLI \_ PACKAGING \_ EMBALLAGES \_ VERPACKUNGEN

FORMATO SIZES FORMAT FORMAT	SCATOLA_BOX_CARTON_KARTON			PALLET		
	PEZZI PIECES PIÈCES STÜCKZAHL	M <sup>2</sup>	KG	SCATOLE BOXES CARTONS KARTONS	M <sup>2</sup>	KG
60x120	2	1,44	33,00	14	20,16	462
60x60	3	1,08	24,50	40	43,20	980
30x60	6	1,08	24,50	40	43,20	980
30x30	12	1,08	24,50	40	43,20	980

---

# CAVA ALBORENSIS

SORGENTE DI MATERIA

---



**KRONOS**  
CERAMICHE

Kronos 2 ceramiche S.p.A.  
Sede legale: Strada delle Fornaci, 20  
41126 Modena  
Sede amministrativa: Via Monte Bianco, 3  
41042 Fiorano Modenese  
(Modena) Italy  
Tel. 0039 0536 927711  
Fax 0039 0536 845608  
info@kronos2.it  
www.kronosceramiche.it